

SPECIFICATIONS

- Cast components will be of 100% recycled aluminum; ASTM B261.

- Castings will be squared and flat, free of burrs, slag, air pockets, blow holes, flashing, and grinding or welding on exposed surfaces. Excessive warping or shrinkage is not acceptable.

- Fabricated components will be mild carbon steel, ASTM A36.

- All visible welds to be ground smooth on outside edges.

- Fabrication will be true to square, or diameter and sized within 1/8".

- Finish to be powder coat, standard UA color and applied per UA specifications. If alternate color or finish is required, please provide all finish information for UA approval.

- Dimensions shown are nominal.

- For cases of "or equal" consideration, our finished, full size product should be compared with the alternative product for general quality, surface finish, precise pattern work, metal characteristics, and overall design aesthetics.

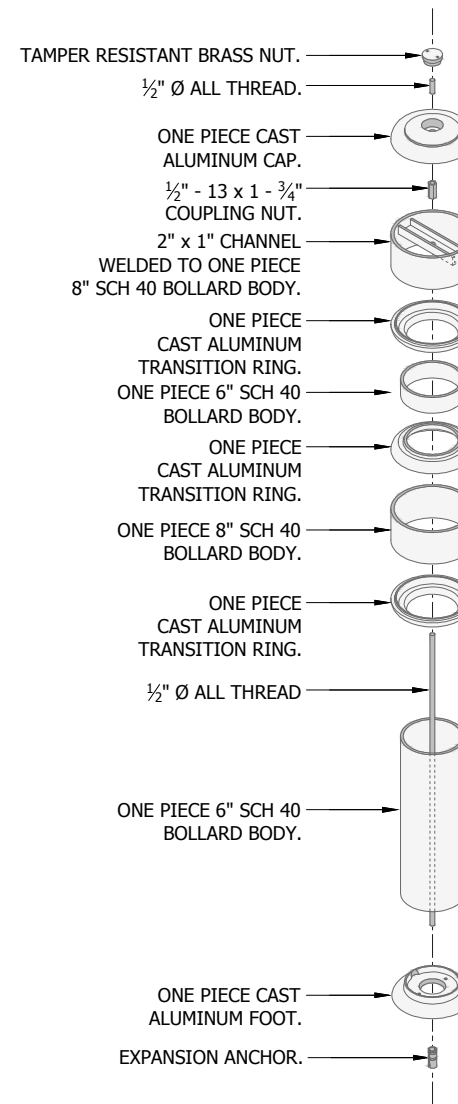
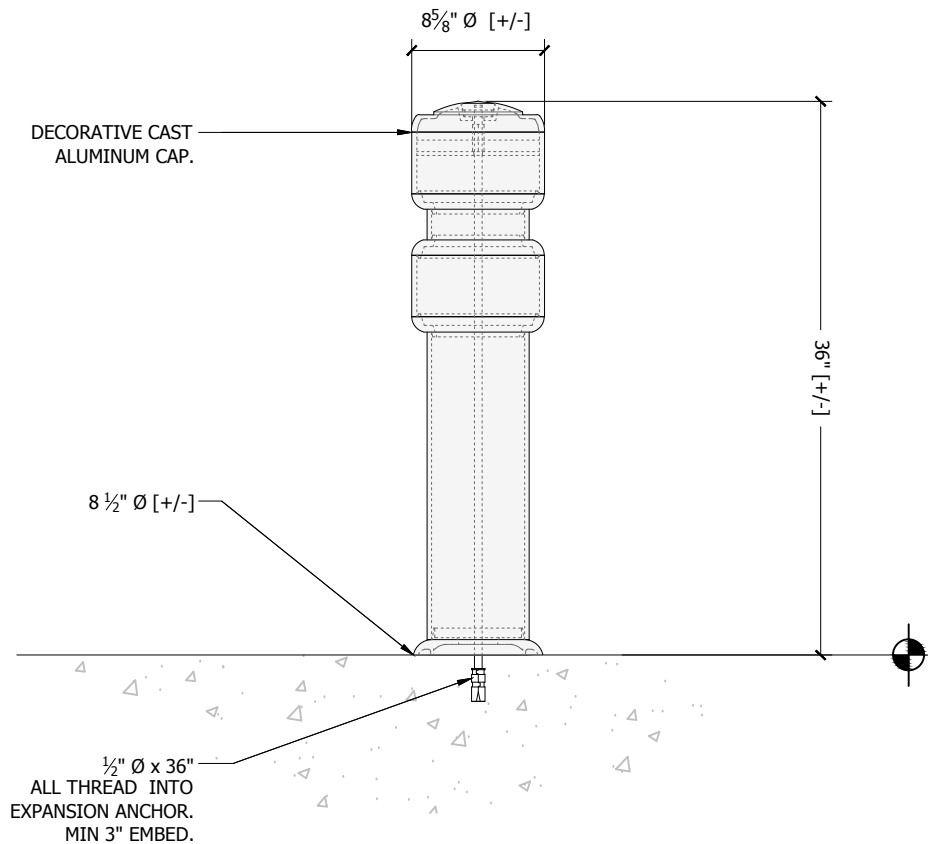

Bollard

5C2 Surface Mount

Page: 1 of 1 Date: 2/5/13



465 E. FIFTEENTH ST. sales@urbanaccessories.com
TACOMA, WA 98421 www.urbanaccessories.com
(877) 487-0488